

# TASTE

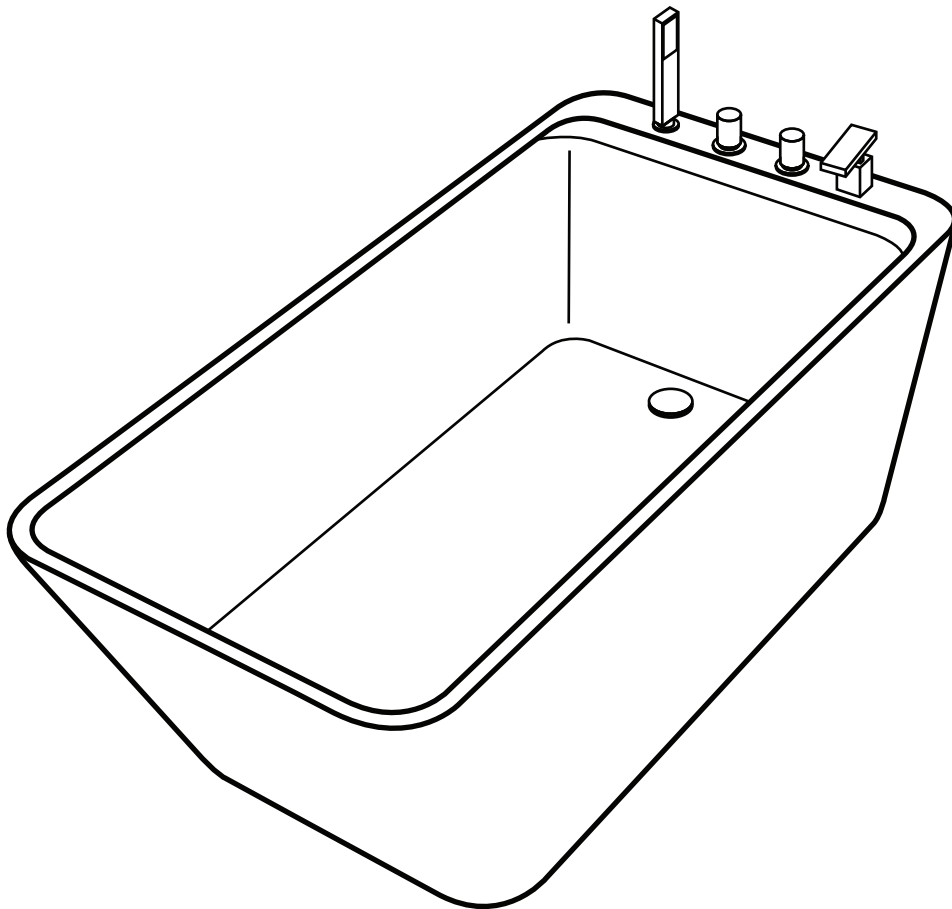

EN 14516:2006+A1:2010 (14)



**bathlife**  
ofsweden  
.com

© 2016



**bathlife**<sup>®</sup>

OF SWEDEN

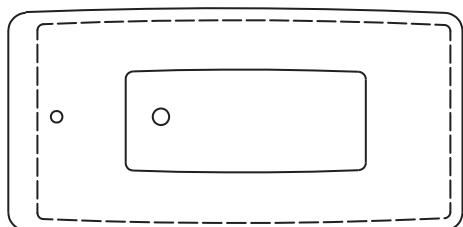

**x1**

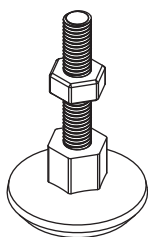

**x4**

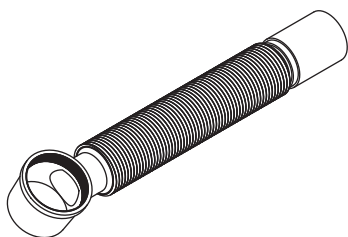

**x1**

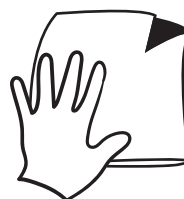
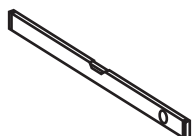



VITAL ✗ ECO ✓ PLUS ✓

---

≥0,23 MPa

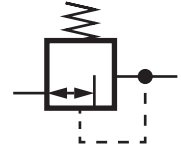

MAX 60°C

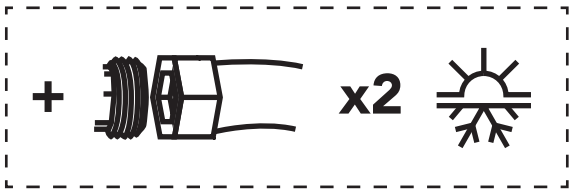

VITAL ✗ ECO ✓ PLUS ✓

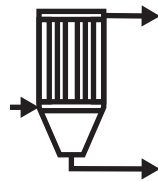
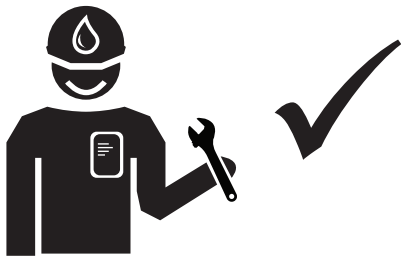

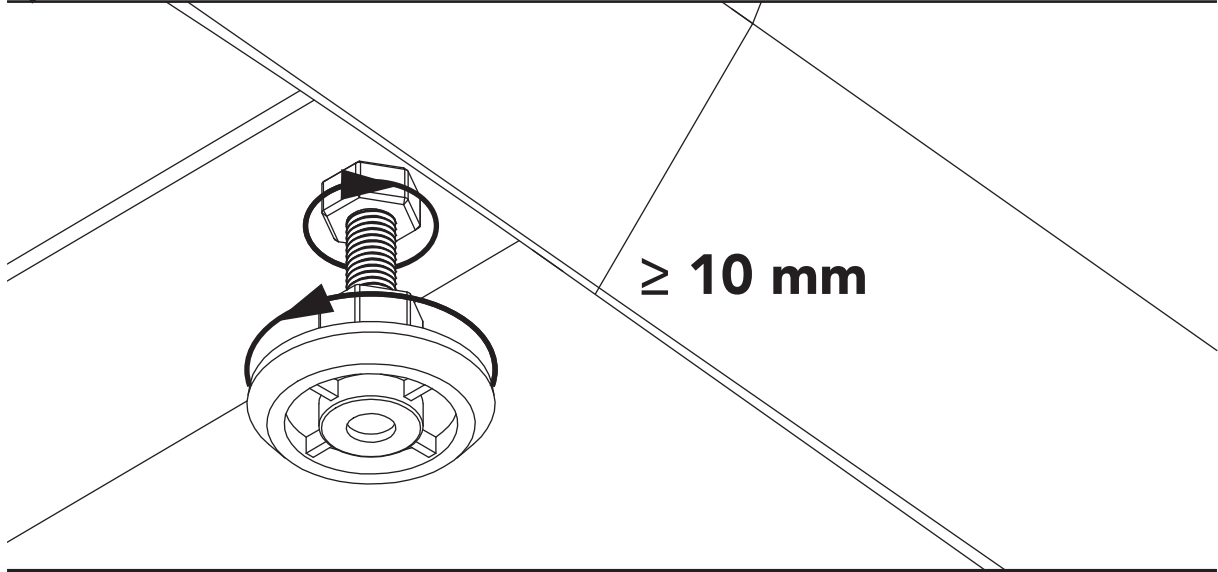
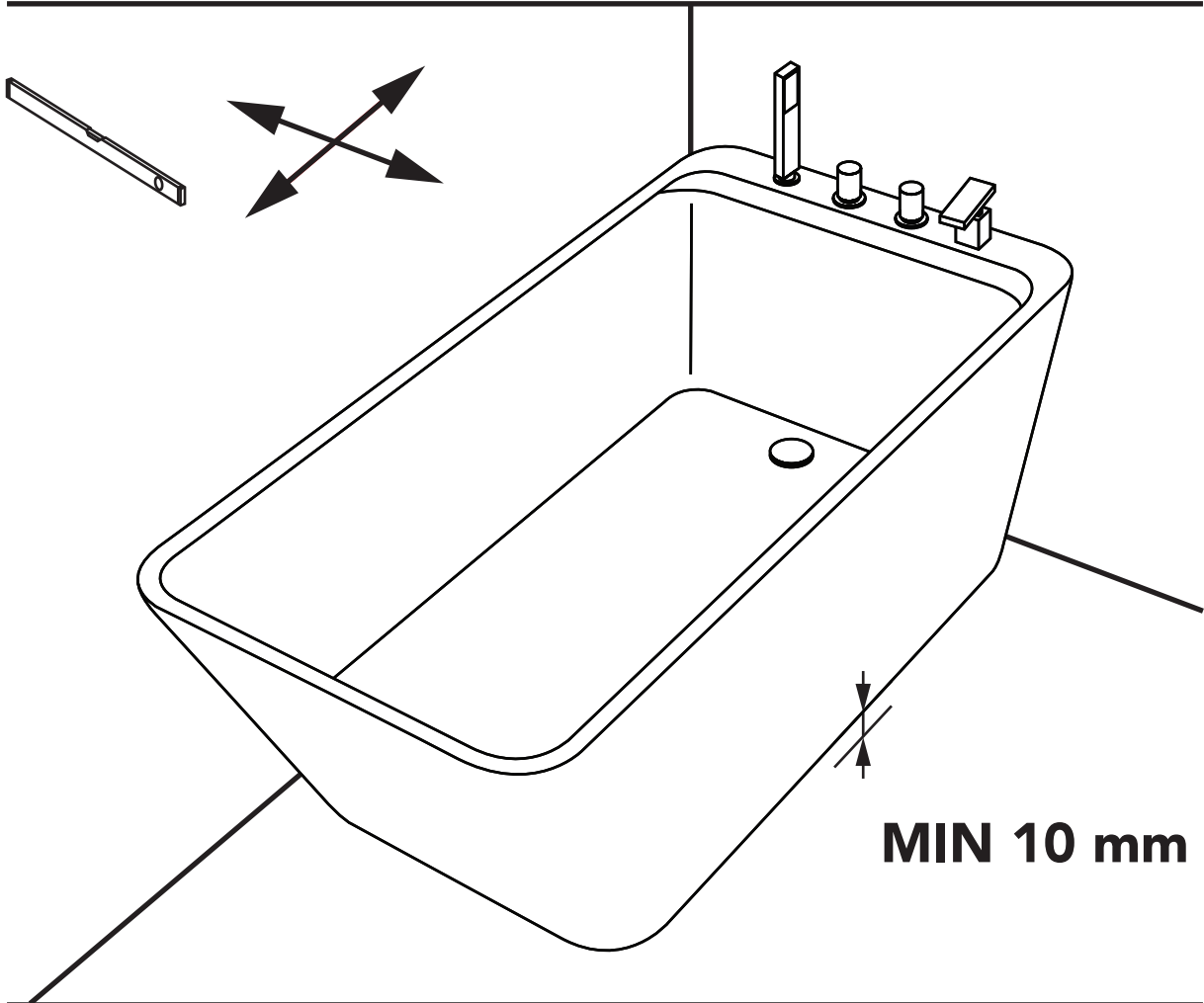
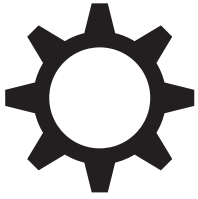

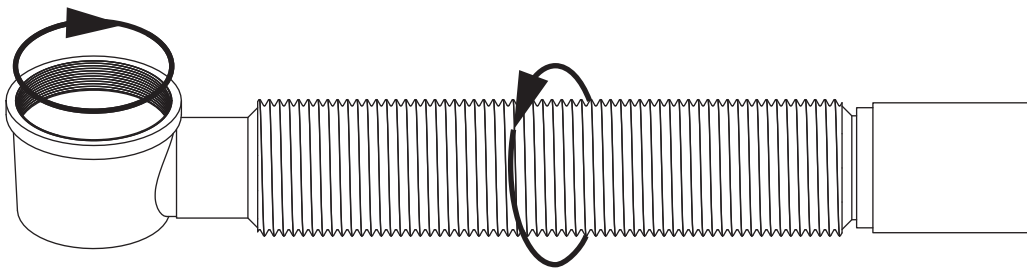
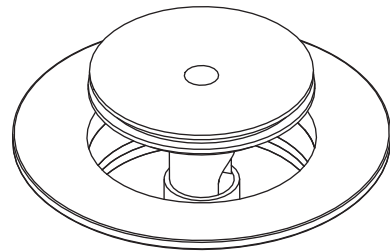
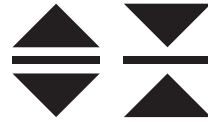
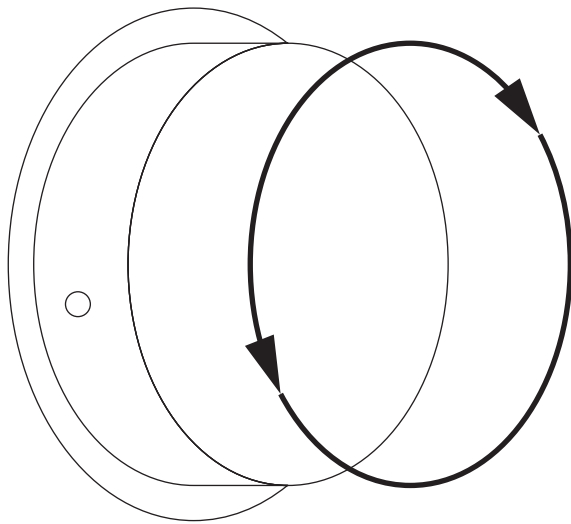
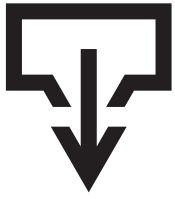

**400 - 1200 mm**

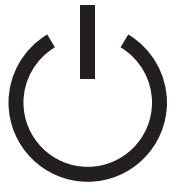

VITAL ✗ ECO ✓ PLUS ✓

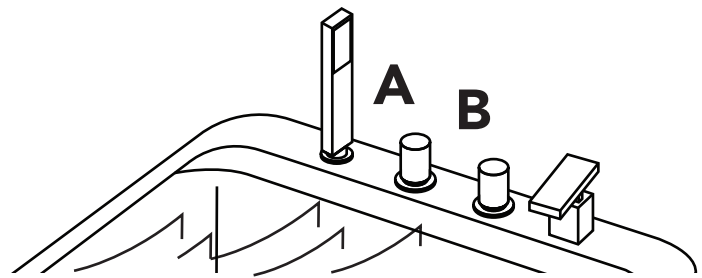
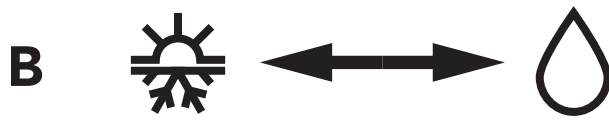
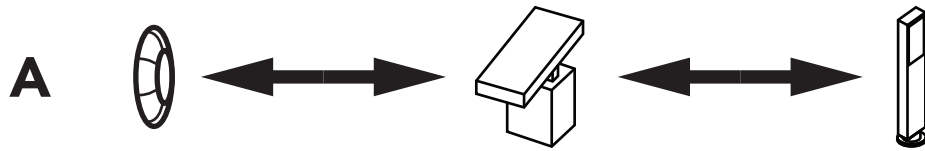



Never use chemicals with bleaching or abrasive properties.  
Använd aldrig kemikalier med blekande eller slipande egenskaper.  
Bruk aldri kjemikalier med blegning eller slipende egenskaper.  
Brug aldrig kemikalier med blegemiddel eller slibende egenskaber.  
Älä koskaan käytä kemikaaleja valkaisevaa tai hankaavia ominaisuuksia.  
Verwenden sie niemals chemikalien mit bleichmittel oder abrasiven eigenschaften.

