

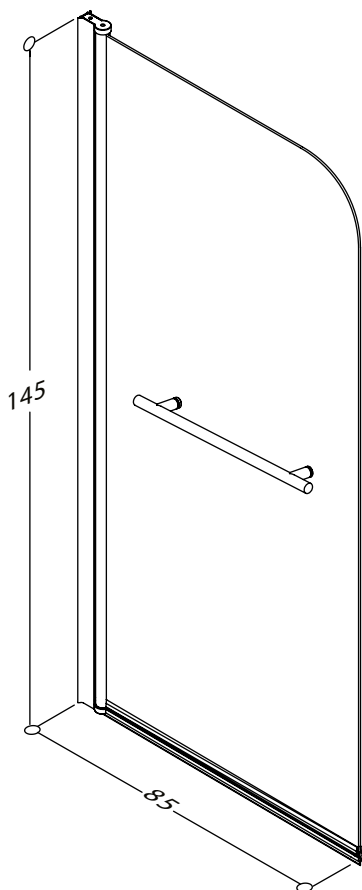

bathlife®

OF SWEDEN

SKVALA



85 x 145 cm (max 86 cm)

MAINTENANCE

AFTER INSTALLATION

Seal seams of the frame with silicon. Use neutral detergent to clean the aluminium frame and glass and polish them with a soft cloth. Let the seems rest for 24 hours to guarantee the waterproof construction.

EVERYDAY CARE

Open and close doors gently to avoid the damage of the glass. Oil the sliding elements every month to guarantee the smooth sliding. Do not use acid or alkali solutions and knives to scrape the shower room. Perform gentle cleaning and maintenance periodically. Keep the door open to have the shower area well ventilated.

level ruler

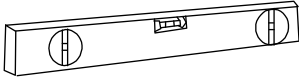

tape measure

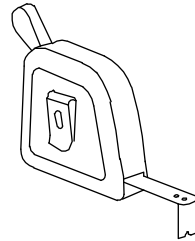

pencil



ruler

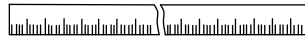

3 mm drills



electric drill

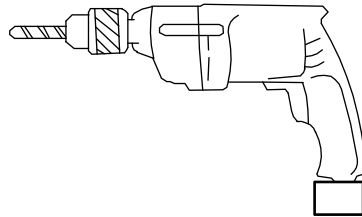

screwdrivers blades



organic glass gun

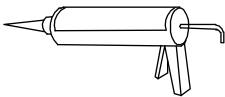

screwdriver

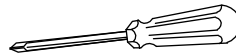



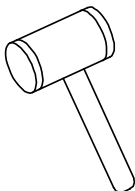



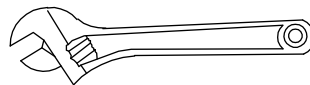





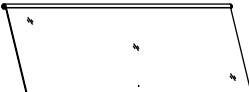

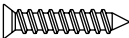

rawhide hammer



spanner

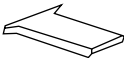

COMPONENTS

CODE	NAME	MODEL	QTY
A	Wall fixing profile		1
B	Vertical chrome profile		1
C	Sliding glass		1
D	Door end water proof belt		1
E	Frame fixer (R)		1
F	Frame fixer (L)		1
G	Expansion pipe screw		3
H	H1 Countersunk screw ST4.2x25mm	 	2
	H2 Round head screw ST4x30mm	 	3
	H3 Round head screw ST4x12mm	 	2
I	Outside screw cap		2
J	Inside screw cap		2
K	Cover cap		1
L	Handles		1

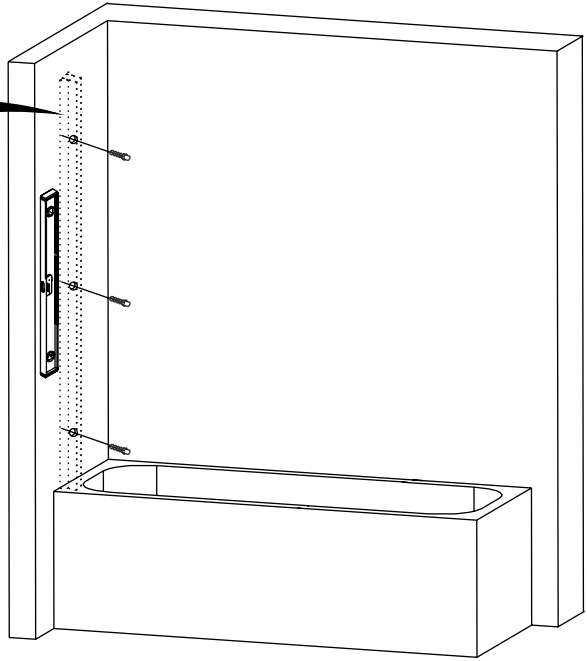
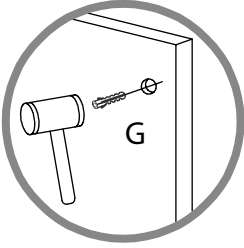
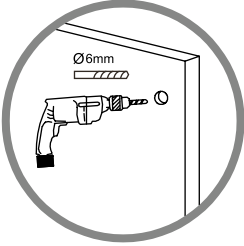
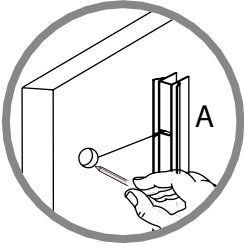

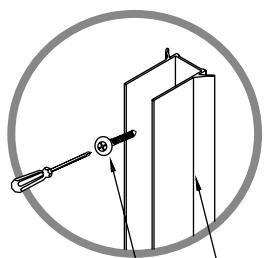

H2

A

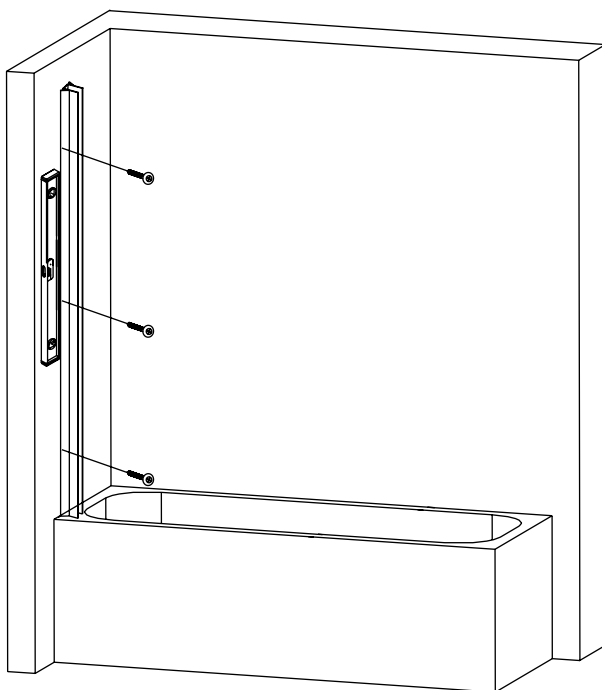

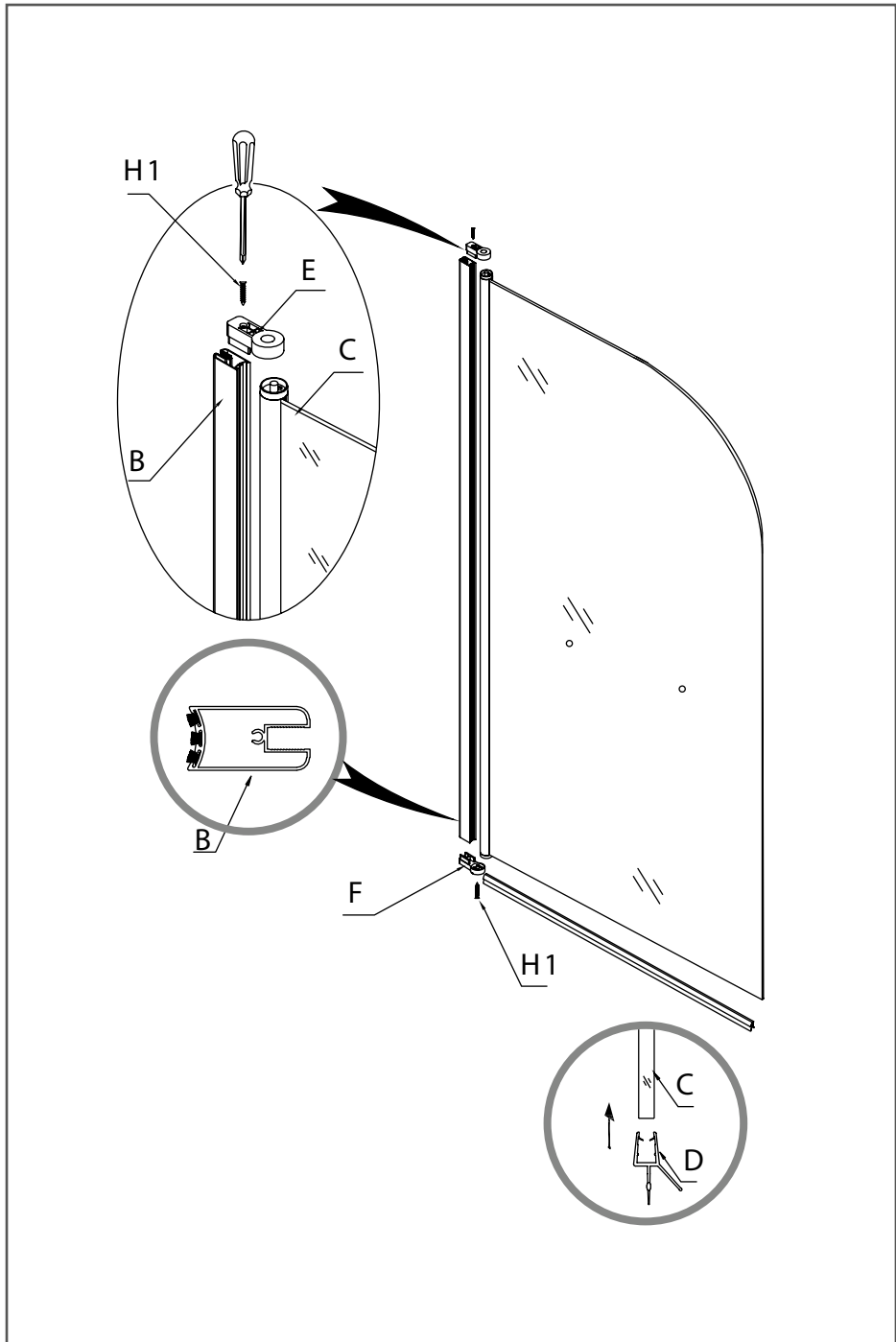

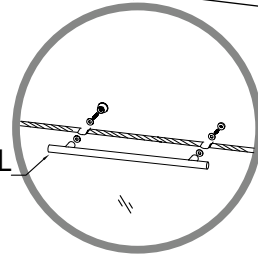
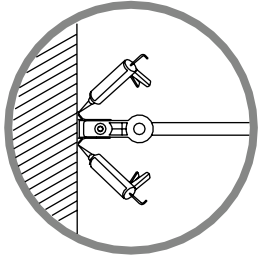
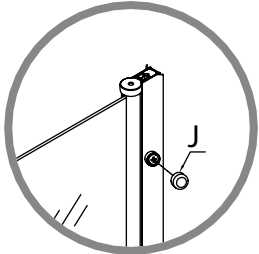
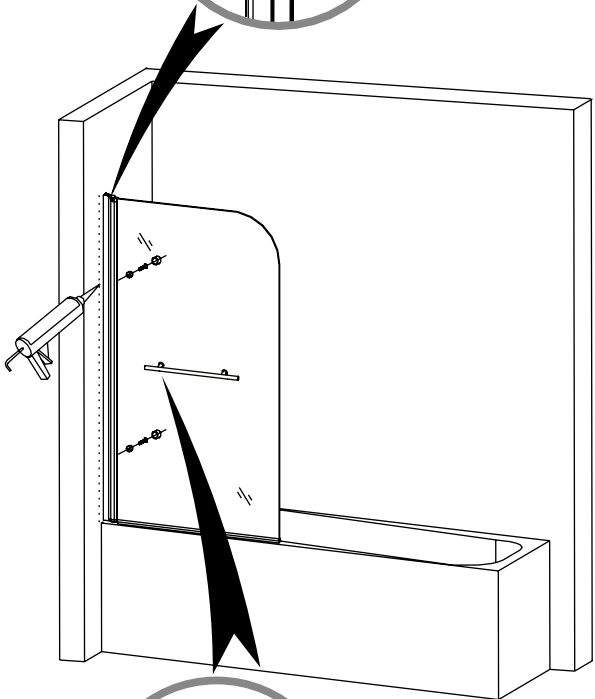
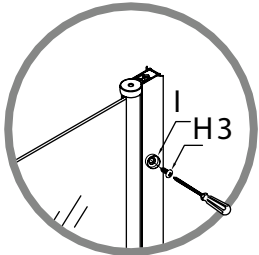
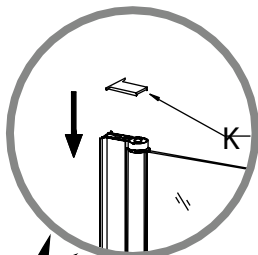
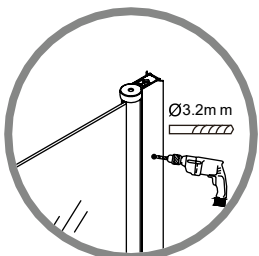
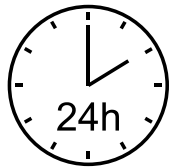
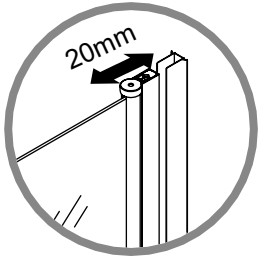

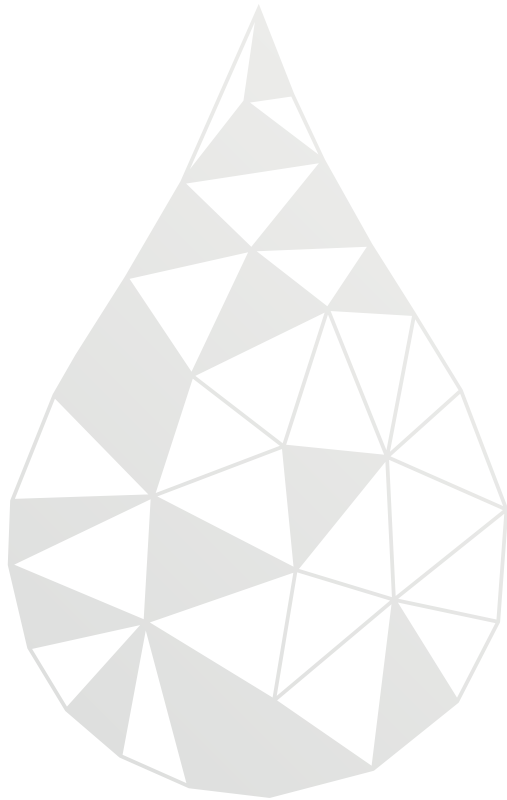

Copyright ©2017 Bygghemma Sverige AB. All rights reserved. Bygghemma Group Nordic AB is the registered holder of the bathlife® logo.



Information contained within this document was considered accurate at the time of publication, but may be subject to revision.